

PLAN VIEW - SINGLE-ACCOMMODATION TOILET  
OUT SWING DOOR -  
FLOOR SPACE - MANUEVERING SPACE DIMENSIONS

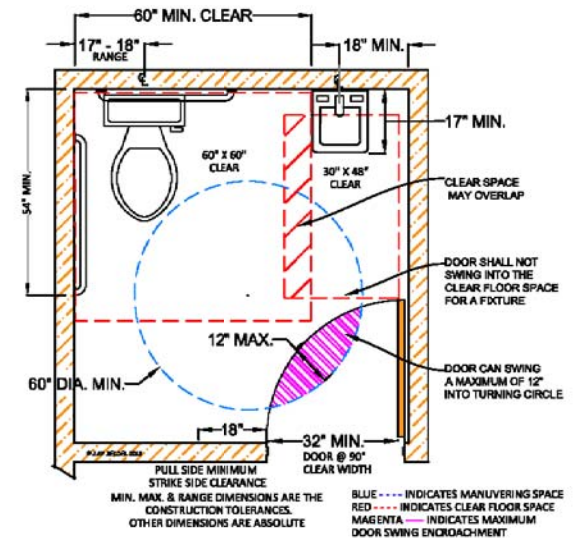

PLAN VIEW - SINGLE-ACCOMMODATION TOILET  
IN SWING DOOR -  
FLOOR SPACE - MANUEVERING SPACE DIMENSIONS

\* NEW FOR 2013 CBC CODE - SEE 118-609. AN L-SHAPED GRAB BAR MEETING THE DIMENSIONAL REQUIREMENTS OF 118-604.5.1 IS PERMITTED.

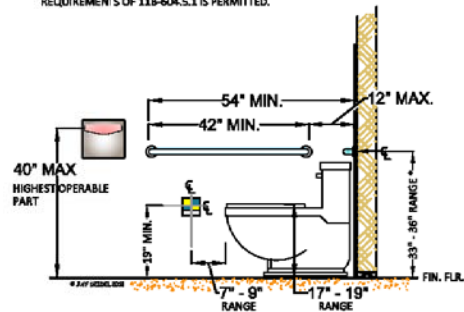

SIDE ELEVATION - ACCESSIBLE TOILET  
AND ACCESSORIES MOUNTING DIMENSIONS

PER CBC 118-305, OPERABLE PARTS SHALL BE OPERABLE WITH ONE HAND AND SHALL NOT REQUIRE TIGHT GRASPING, PINCHING OR TWISTING OF THE WRIST. THE FORCE REQUIRED TO ACTIVATE OPERABLE PARTS SHALL BE 5 lbf. MAXIMUM.

HAND-OPERATED METERING FAUCETS REMAINS OPEN FOR AT LEAST 10 SECONDS MINIMUM. CBC 118-604.4

\* NEW FOR 2013 CBC CODE - SEE 118-609. AN L-SHAPED GRAB BAR MEETING THE DIMENSIONAL REQUIREMENTS OF 118-604.5.1 IS PERMITTED.

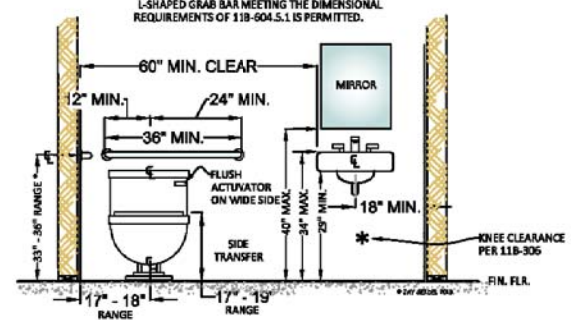

FRONT ELEVATION - ACCESSIBLE TOILET  
AND ACCESSORIES MOUNTING DIMENSIONS



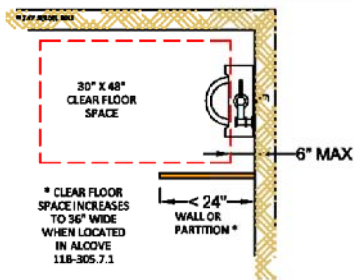

ALCOVE FORWARD  
APPROACH URINAL CLEARANCE  
PLAN VIEW 11B-605.2

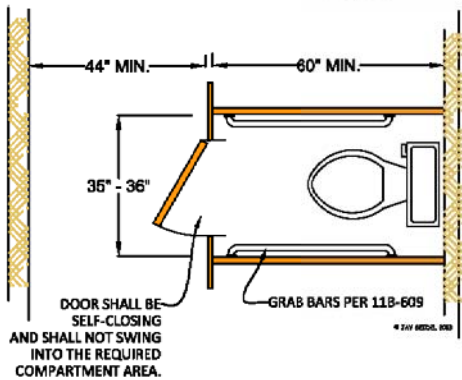

AMBULATORY ACCESSIBLE TOILET  
COMPARTMENT 11B-604.8.2

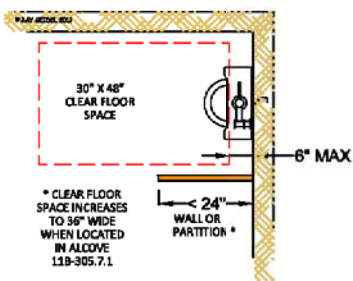

ALCOVE FORWARD  
APPROACH URINAL CLEARANCE  
PLAN VIEW 11B-605.2

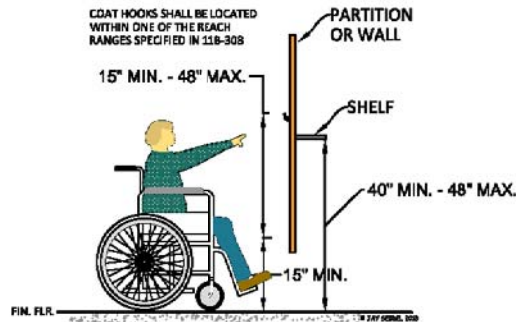

MIN. MAX. & RANGE DIMENSIONS ARE THE CONSTRUCTION TOLERANCES. OTHER DIMENSIONS ARE ABSOLUTE

COAT HOOKS AND SHELVES  
11B-604.8.3

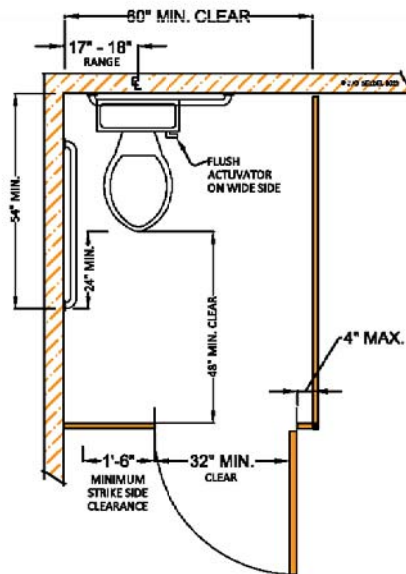

MIN. MAX. & RANGE DIMENSIONS ARE THE CONSTRUCTION TOLERANCES. OTHER DIMENSIONS ARE ABSOLUTE

MULTI-ACCOMMODATION TOILET FACILITY  
PLAN VIEW

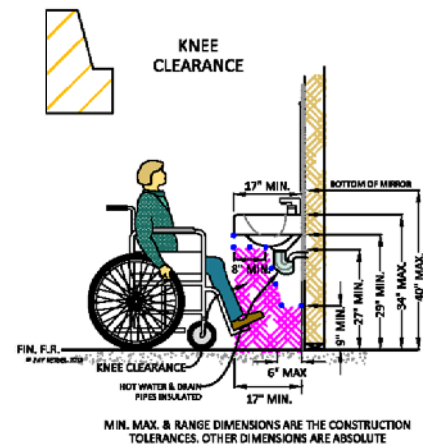

MIN. MAX. & RANGE DIMENSIONS ARE THE CONSTRUCTION TOLERANCES. OTHER DIMENSIONS ARE ABSOLUTE

SIDE ELEVATION - KNEE CLEARANCE  
AND SINK MOUNTING DIMENSIONS

